

Plug-in connection system, Screw connection, No. of poles: 19, Width: 98.04 mm, Colour: Green

Business data

Article number	<u>12336.1</u>
Article name	PK-TS/19/5,08 GN
GTIN (EAN)	4044211030056
Connector version	Attached plug-in connector
Packaging unit	25
Quantity unit	PC
Packaging type	Carton
Type of banding	Without
Weight per piece (not including packaging)	50.8 g
Weight per piece (including packaging)	56.4 g
Unit of weight	G
Customs number	85366930
Country of origin	TN
Colour	Green

Technical data

Dimensions

Length	42.5 mm
Length of male pin block	20.6 mm
Width	98.04 mm
Width left	3.3 mm
Width right	3.3 mm
Height TS 35/7.5	35.5 mm
Height TS 32	40.5 mm
Pitch	5.08 mm

Ratings

Rated voltage	250 V
Rated current	10 A
Rated cross-section	2.5 mm ²
Rated impulse voltage	4 kV
Overvoltage category	III
Contamination degree	3

Connection data

Connection principle	Screw connection
Angle of wire connection/contact	90° (vertically upwards)
No. of poles	19
Wire cross-section single-core (rigid) / stranded, min.	0.2 mm ²
Wire cross-section single core (rigid)/stranded, max.	4 mm ²
Wire cross-section stranded, min.	0.2 mm ²
Wire cross-section stranded, max.	2.5 mm ²
Wire cross-section stranded with wire-end ferrules, min.	0.25 mm ²
Wire cross-section stranded with wire-end ferrules, max.	2.5 mm ²
Wire cross-section AWG, min.	28
Wire cross-section AWG, max.	12
Stripping length	6 mm
Screw threading	M 3
Torque	0.5 Nm

Technical data

Materials

Insulation housing	Polyamide 6.6
Flammability class UL 94	V-0
Working temperature, min.	-30 °C
Working temperature, max.	105 °C
Clamping element	Brass
Contact flag	Copper alloy
Screws	Steel

Further technical data

Storage temperature, min.	-40 °C
Storage temperature, max.	105 °C
Insulation resistance	1*10 ¹³ Ohm x cm
Creepage-current resistance	CTI 600
Glow wire flammability index GWFI	GWFI 850
GWFI after-glow time	30 Sek.
Glow wire ignition temperature GWIT	GWIT 775 °C
GWIT exposure time	5 Sek.
Connection cycles, in compliance with standard	5
Plug-in cycles acc. to standard	100

Environmental Product Compliance

REACH Conform	No
REACH Reference date	2024-01-23
REACH Candidate Substance Note	No
REACH CAS 1 Substance	LEAD
REACH CAS 1 Percent minimal	0.1 %
REACH CAS 1 Percent maximum	4 %
REACH CAS 1 Number	7439-92-1
RoHS Conform	yes
RoHS Exception rule	6c

Approvals

cUL Recognized

cUL approval	C22.2 No 158
cUL Usegroup B: rated voltage	300 V
cUL Usegroup B: rated current	15 A
cUL Usegroup C: rated voltage	300 V
cUL Usegroup C: rated current	15 A
cUL Usegroup D: rated voltage	300 V
cUL Usegroup D: rated current	15 A
cUL wire cross-section single-core (rigid) AWG, min.	28
cUL wire cross-section single-core (rigid) AWG, max.	12
cUL wire cross-section stranded AWG, min.	28
cUL wire cross-section stranded AWG, max.	12
cUL torque	0.45 Nm
cUL wire material	Cu
cUL Recognized	1

UL Recognized

UL approval	UL 1059
UL Usegroup B: rated voltage	300 V
UL Usegroup B: rated current	15 A
UL Usegroup C: rated voltage	300 V
UL Usegroup C: rated current	15 A
UL Usegroup D: rated voltage	300 V
UL Usegroup D: rated current	15 A
UL wire cross-section single-core (rigid) AWG, min.	28
UL wire cross-section single-core (rigid) AWG, max.	12
UL wire cross-section stranded AWG, min.	28
UL wire cross-section stranded AWG, max.	12
UL torque	4 Lb In
UL wire material	Cu
UL factory wiring	1
UL field wiring	1
UL Recognized	1

Approvals

VDE approval

VDE approval	DIN EN 61984
VDE approval granted	yes
VDE rated voltage	250 V
VDE rated current	10 A
VDE rated current wire cross-section rigid, min.	6 A
VDE rated current wire cross-section rigid, max.	10 A
VDE rated current wire cross-section stranded, min.	6 A
VDE rated current wire cross-section stranded, max.	10 A
VDE rated impulse voltage	4 kV
VDE wire cross-section rigid, min.	0.5 mm ²
VDE wire cross-section rigid, max.	2.5 mm ²
VDE wire cross-section stranded, min.	0.5 mm ²
VDE wire cross-section stranded, max.	2.5 mm ²
VDE overvoltage category	III
VDE contamination degree	3

Media

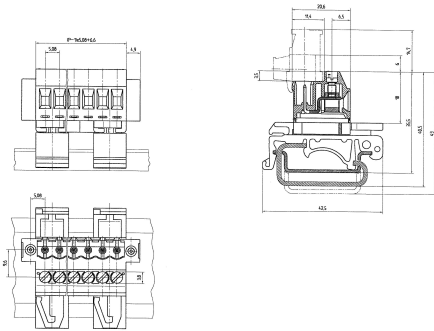

M3

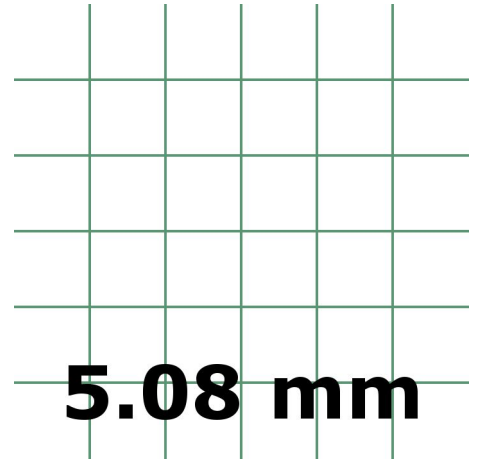

5.08 mm

C  **US**

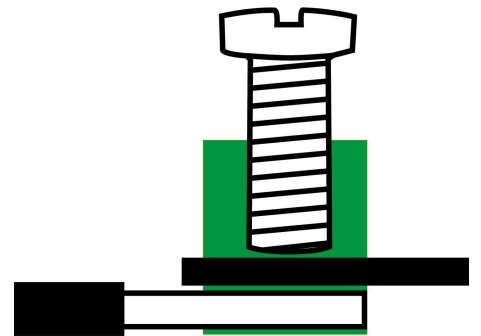

Accessories
