

Female socket block, Push-in connection, No. of poles: 21, Width: 106.6 mm, Colour: Pebble grey

Business data

Article number	<u>13127.0</u>
Article name	PBK 4101/21/5,00-KD LG
GTIN (EAN)	4044211042028
Packaging unit	50
Quantity unit	PC
Packaging type	Carton
Type of banding	Without
Weight per piece (not including packaging)	14 g
Weight per piece (including packaging)	15.7 g
Unit of weight	G
Customs number	85366930
Country of origin	QU
Colour	Pebble grey

Technical data

Dimensions

Length	12.5 mm
Length of the pin	3.6 mm
Width	106.6 mm
Width left	3.5 mm
Width right	3.1 mm
Height	9.2 mm
Drill hole diameter	1 mm
Diameter of connecting pin	0.4 mm
Pitch	5 mm

Ratings

Rated voltage	250 V
Rated current	17.5 A
Rated cross-section	1.5 mm ²
Rated impulse voltage	2 kV
Overvoltage category	III
Contamination degree	3

Connection data

Connection principle	Push-in connection
Connection type of PCB	Connecting contact
Type of attachment to circuit board	Solder connection
Angle of PCB/wire connection	0°/180° (horizontal)
No. of poles	21
Number of levels	1
Wire cross-section single-core (rigid) / stranded, min.	0.08 mm ²
Wire cross-section single core (rigid)/stranded, max.	2.5 mm ²
Wire cross-section stranded, min.	0.5 mm ²
Wire cross-section stranded, max.	1.5 mm ²
Wire cross-section stranded with wire-end ferrules, min.	0.14 mm ²
Wire cross-section stranded with wire-end ferrules, max.	1 mm ²
Wire cross-section AWG, min.	20
Wire cross-section AWG, max.	14
Stripping length	9 mm

Technical data

Materials

Insulation housing	Polyamide 6.6
Flammability class UL 94	V-0
Working temperature, min.	-30 °C
Working temperature, max.	105 °C
Terminal spring	Stainless steel
Soldering lug	Copper alloy

Further technical data

Storage temperature, min.	-40 °C
Storage temperature, max.	105 °C
Insulation resistance	1*10 ¹³ Ohm x cm
Creepage-current resistance	CTI 600
Glow wire flammability index GWFI	GWFI 850
GWFI after-glow time	30 Sek.
Glow wire ignition temperature GWIT	GWIT 775 °C
GWIT exposure time	5 Sek.
Connection cycles, in compliance with standard	10
Recommended wave soldering temperature	265 °C
Recommended wave soldering duration, min.	3 Sek.
Recommended wave soldering duration, max.	4 Sek.

Environmental Product Compliance

REACH Conform	yes
REACH Reference date	2024-01-23
REACH Candidate Substance Note	No
RoHS Conform	yes

Approvals

cUL Recognized

cUL approval	CSA 22.2 No.158
cUL Usegroup B: rated voltage	300 V
cUL Usegroup B: rated current	10 A
cUL Usegroup D: rated voltage	300 V
cUL Usegroup D: rated current	10 A
cUL wire cross-section single-core (rigid) AWG, min.	20
cUL wire cross-section single-core (rigid) AWG, max.	14
cUL wire material	Cu
cUL Recognized	1

UL Recognized

UL approval	UL 1059
UL Usegroup B: rated voltage	300 V
UL Usegroup B: rated current	10 A
UL Usegroup D: rated voltage	300 V
UL Usegroup D: rated current	10 A
UL wire cross-section single-core (rigid) AWG, min.	20
UL wire cross-section single-core (rigid) AWG, max.	14
UL wire material	Cu
UL factory wiring	1
UL field wiring	1
UL Recognized	1

VDE approval

VDE approval	DIN EN 60998
VDE approval granted	yes
VDE rated voltage	250 V
VDE rated current	17.5 A
VDE rated current wire cross-section rigid, max.	17.5 A
VDE rated impulse voltage	2 kV
VDE wire cross-section rigid, min.	0.5 mm ²
VDE wire cross-section rigid, max.	2.5 mm ²
VDE overvoltage category	III
VDE contamination degree	3

Media

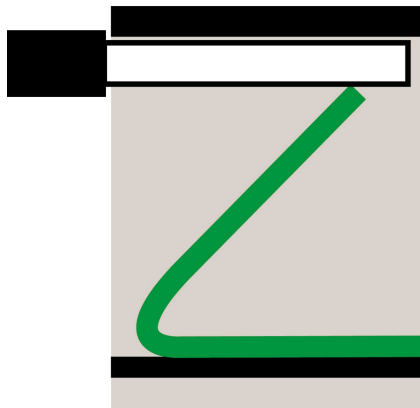
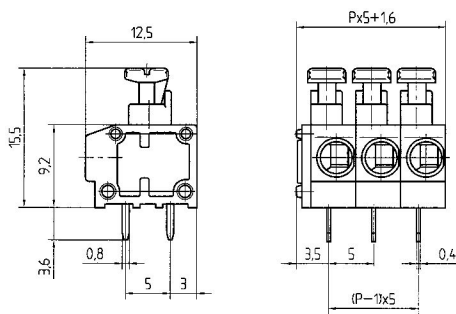

Accessories
