

15535.2 ZPSCU 1/240V AC/240V AC

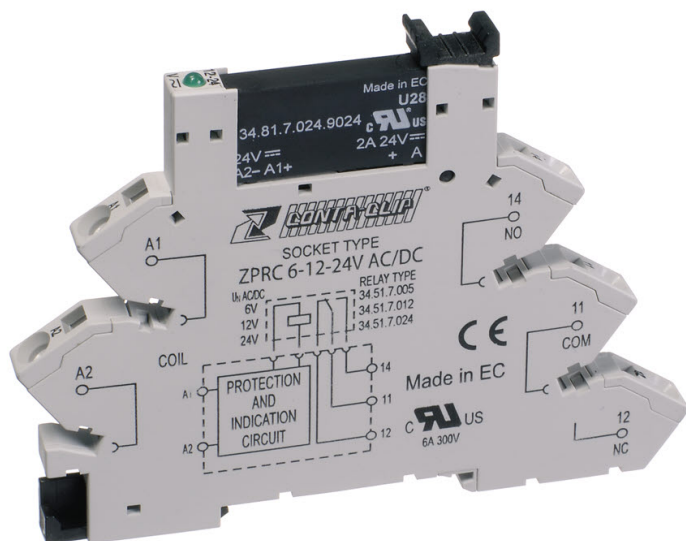

Plug-Solid-State-Compact (PSC) Complete, Consisting of base PRC... with tension-spring connection and plug-in miniature SSR PSC..., Mounting type: Mounting rail TS 35, 1 NO contact, Input voltage: 240 VAC

Business data

Article number	<u>15535.2</u>
Article name	ZPSCU 1/240V AC/240V AC
GTIN (EAN)	4044211118747
Packaging unit	10
Quantity unit	PC
Weight per piece (not including packaging)	33.2 g
Weight per piece (including packaging)	35 g
Unit of weight	G
Customs number	85364900
Country of origin	DE
Product description	Solid-state terminal

15535.2 ZPSCU 1/240V AC/240V AC

Technical data

Dimensions

Length	87.3 mm
Width	6.2 mm
Height	79.9 mm

Connection data

Connection principle	Tension-spring connection
Wire cross-section single core (rigid), min.	0.2 mm ²
Wire cross-section single-core (rigid), max.	2.5 mm ²
Wire cross-section stranded, min.	0.2 mm ²
Wire cross-section stranded, max.	2.5 mm ²
Wire cross-section stranded with wire-end ferrules, min.	0.2 mm ²
Wire cross-section stranded with wire-end ferrules, max.	2.5 mm ²
Stripping length	10 mm

Input data

Input voltage	240 VAC
Drop-out voltage	44 VAC
Control current	3 mA
Number of channels	1
Operating range	184-264 VAC
Power consumption	0,9 W

Output data

Output voltage range	12-275 VAC V
Voltage drop at 20 °C and rated current, max.	1,6 VAC V
Switching current, min.	0,022 A
Continuous current max. / Inrush current max.	2 / 40 A
Residual current at 55 °C, max.	1,5 mA

Materials

Working temperature, min.	-20 °C
Working temperature, max.	55 °C

Further technical data

Status display	✓
Response/release time	12 / 12 ms
Test voltage	2.5 kV

Technical data

Environmental Product Compliance

REACH Conform	yes
REACH Reference date	2024-01-23
REACH Candidate Substance Note	No
RoHS Conform	yes

Media

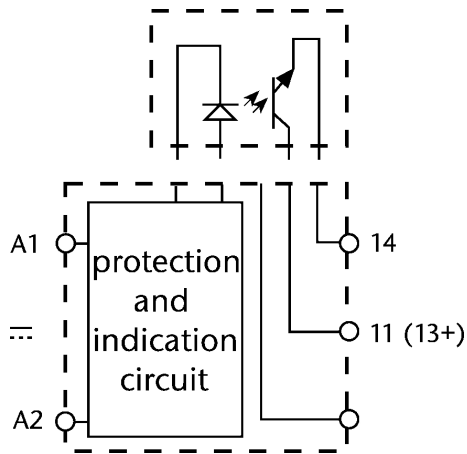
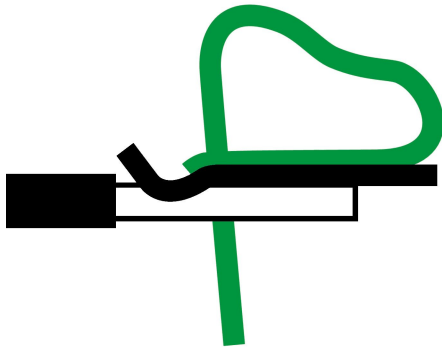

Accessories
