

Data sheet

4062.2 CM 82/8 DT

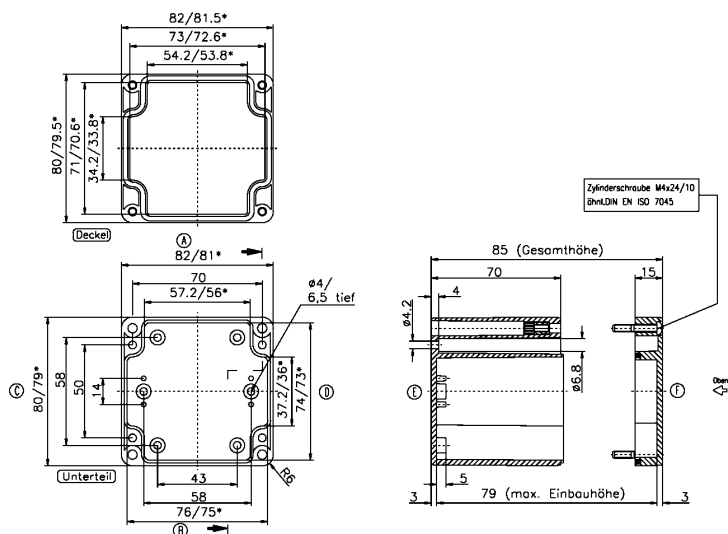

Polycarbonate housing, Colour: Light grey, RAL: 7035, Cover: Polycarbonate, Transparent

RAL: 7035

Business data

Article number	4062.2
Article name	CM 82/8 DT
GTIN (EAN)	4044211061814
Packaging unit	1
Quantity unit	PC
Weight per piece (not including packaging)	201 g
Weight per piece (including packaging)	221 g
Unit of weight	G
Customs number	39269097
Country of origin	EU
Product description	Polycarbonate housing
Colour	Light grey

Technical data

Dimensions

Length	82 mm
Width	80 mm
Height	85 mm

Materials

Material	Polycarbonate
Lid material	Polycarbonate
Lid colour	Transparent
Lid screws	Stainless steel V2A
Flammability class UL 94	V-2
Working temperature, min.	-40 °C
Working temperature, max.	100 °C
Sealing material	Chloroprene
Cadmium-free	✓
Halogen-free	✓
Weather resistant	✓

Further technical data

Degree of protection	IP66
Protection class	II
Impact resistance	IK08
Self-tapping mounting screws for indoor installations	✓
Dielectric strength	30 kV/mm
Surface resistance	>10 ¹² Ohm

Environmental Product Compliance

REACH Conform	yes
REACH Reference date	2024-01-23
REACH Candidate Substance Note	No
RoHS Conform	yes

Media

Accessories

Outer joints

Outer joints, Colour: Light grey

Article number	Article name	GTIN (EAN)	Packaging unit
<u>4510.3</u>	AG/CT/CM (Paar)	4044211064044	1 ST

Mounting plate

Mounting plate, Material: Hard laminated paper, Colour: Brown

Article number	Article name	GTIN (EAN)	Packaging unit
<u>4504.8</u>	MP/M-T/82	4044211063795	1 ST

DIN rail section TS 15/5.5



DIN rail, slotted, Width: 15 mm, Height: 5.5 mm, Material: Steel, Colour: natural

Article number	Article name	GTIN (EAN)	Packaging unit
<u>4507.8</u>	TS 15/68 mm lang	4044211152628	1 ST

Wall brackets

Wall brackets, Material: Polycarbonate, Colour: Grey

Article number	Article name	GTIN (EAN)	Packaging unit
<u>4510.2</u>	WL/CM/CT	4044211064037	1 ST