

Lamp test module, With 40 channels, Common cathode with common collection point, Diode type 1N 4007, Screw connection, Mounting type: Mounting rail TS 35

Business data

Article number	<u>6126.2</u>
Article name	LPM 40-A
GTIN (EAN)	4044211072209
Packaging unit	1
Quantity unit	PC
Weight per piece (not including packaging)	316.1 g
Weight per piece (including packaging)	436.7 g
Unit of weight	G
Customs number	85411000
Country of origin	NL
Prio-Article	6126.2
Product description	Lamp test module
Accessories	Without cover

Technical data

Dimensions

Length	87 mm
Width	216 mm
Height TS 35/7.5	57 mm

Ratings

Overvoltage category	III
Contamination degree	2

Connection data

Connection principle	Screw connection
Wire cross-section single core (rigid), min.	0.2 mm ²
Wire cross-section single-core (rigid), max.	4 mm ²
Wire cross-section stranded, min.	0.2 mm ²
Wire cross-section stranded, max.	2.5 mm ²
Wire cross-section stranded with wire-end ferrules, min.	0.2 mm ²
Wire cross-section stranded with wire-end ferrules, max.	2.5 mm ²
Stripping length	7 mm
Torque	0.6 Nm

Input data

Max. operating voltage AC/DC	250 V
Current load per channel, max.	1 A
Number of channels	40
Shared anode	1

Materials

Working temperature, min.	-20 °C
Working temperature, max.	50 °C

Environmental Product Compliance

REACH Conform	yes
REACH Reference date	2023-06-14, 2024-01-23
REACH Candidate Substance Note	No
RoHS Conform	yes

Approvals

Standards and regulations

Standards / specifications

DIN VDE 0110 / EN 50178

Data sheet

6126.2 LPM 40-A

Media

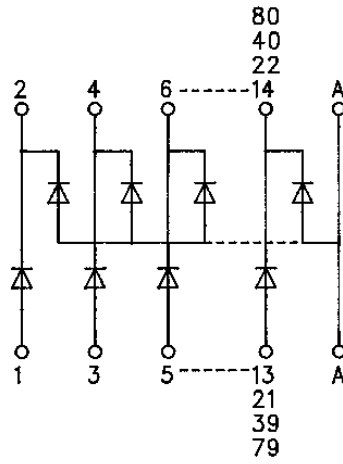
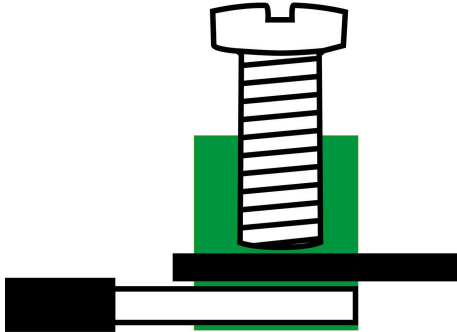

Accessories
