

CONTA-CABLE/ KDSI-SR CABLE ENTRIES

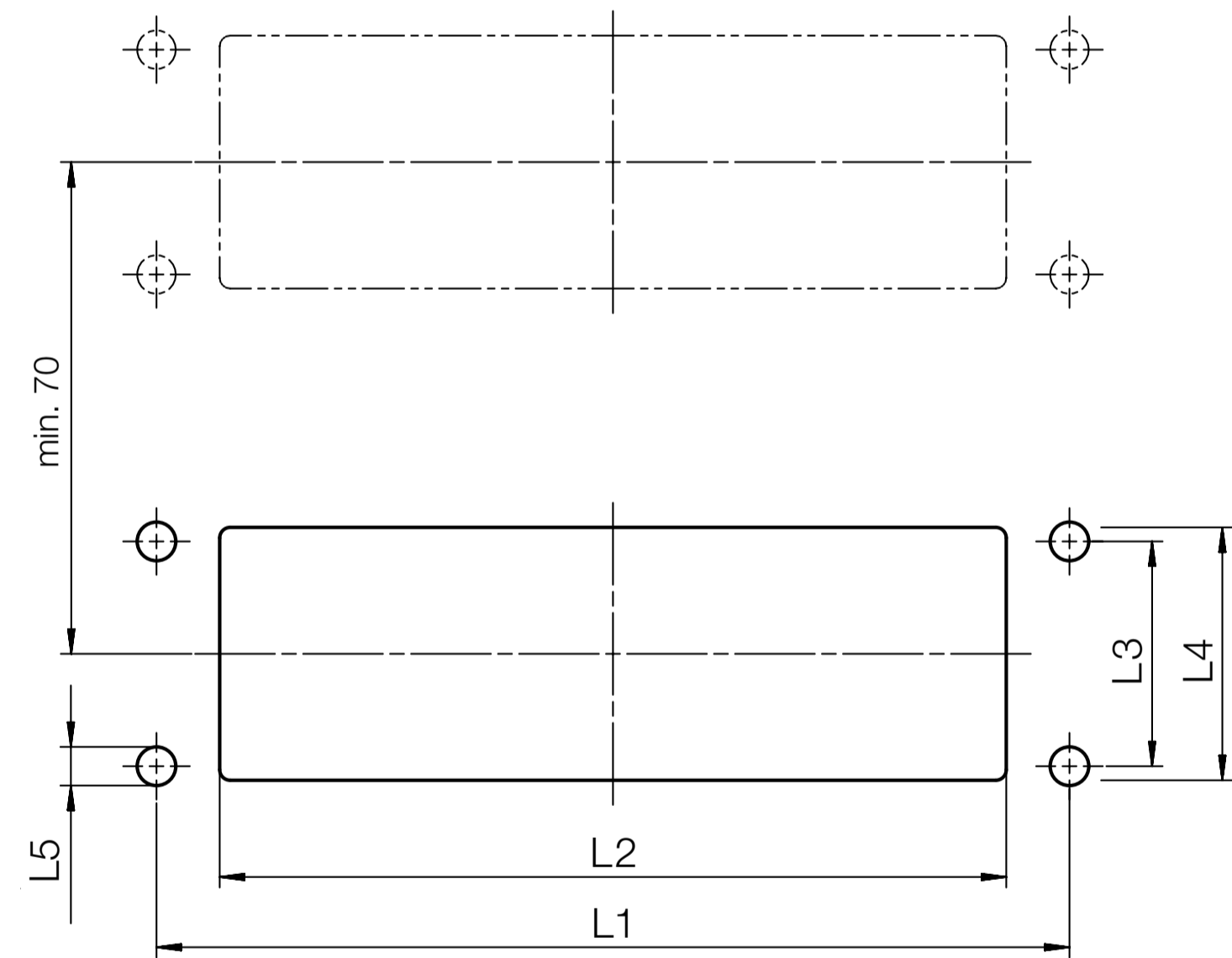

EN DE

PRODUCT DATA

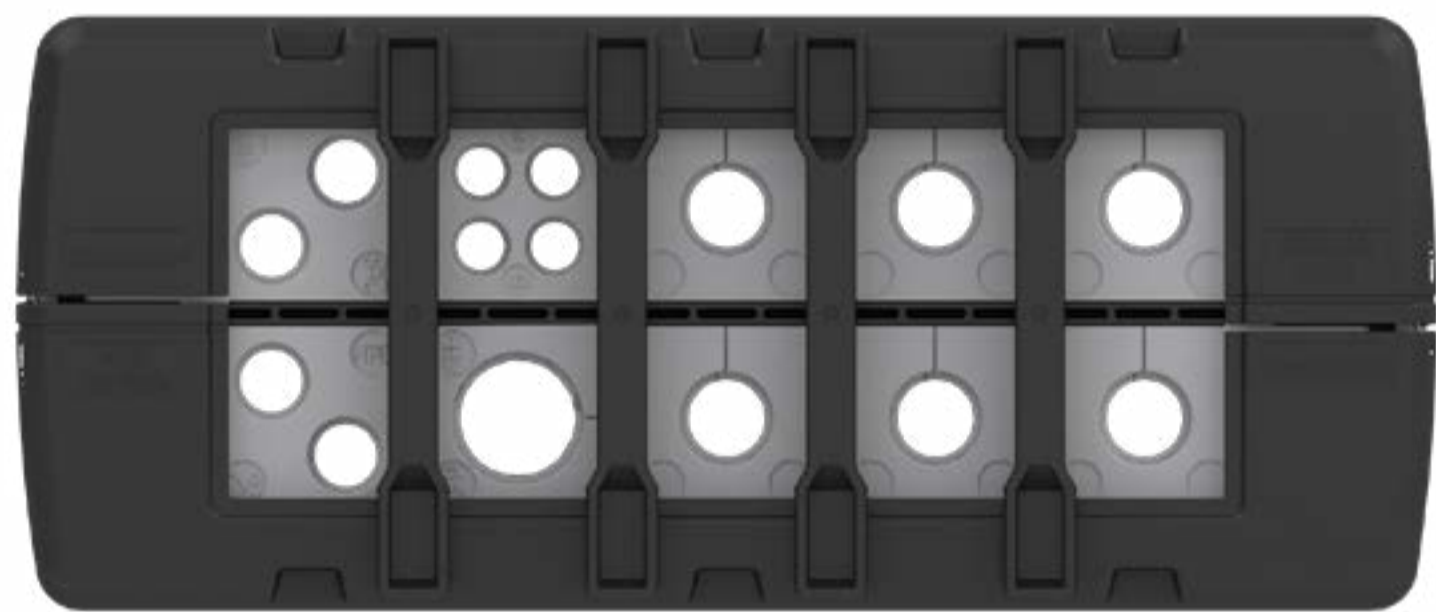

CUT-OUT DIMENSIONS

Frame	Cat.no.	L1(mm)	L2(mm)	L3(mm)	L4(mm)	L5(mm)
KDSI-SR 1-4	28880.4	58	46	32	36-46	5.5
KDSI-SR 6/10	28881.4	83	68.5	32	36-46	5.5
KDSI-SR 8/16	28882.4	103	91	32	36-46	5.5
KDSI-SR 10/24	28883.4	130	113.5	32	36-46	5.5

USAGE OPTIONS

Frame	Inlay			
	1	2	4	6
KDSI-SR 1-4	28516.4	28517.4	28518.4	28519.4
KDSI-SR 6/10		x	x	x
KDSI-SR 8/16	x		x	
KDSI-SR 10/24		x	x	x

INSTALLATION

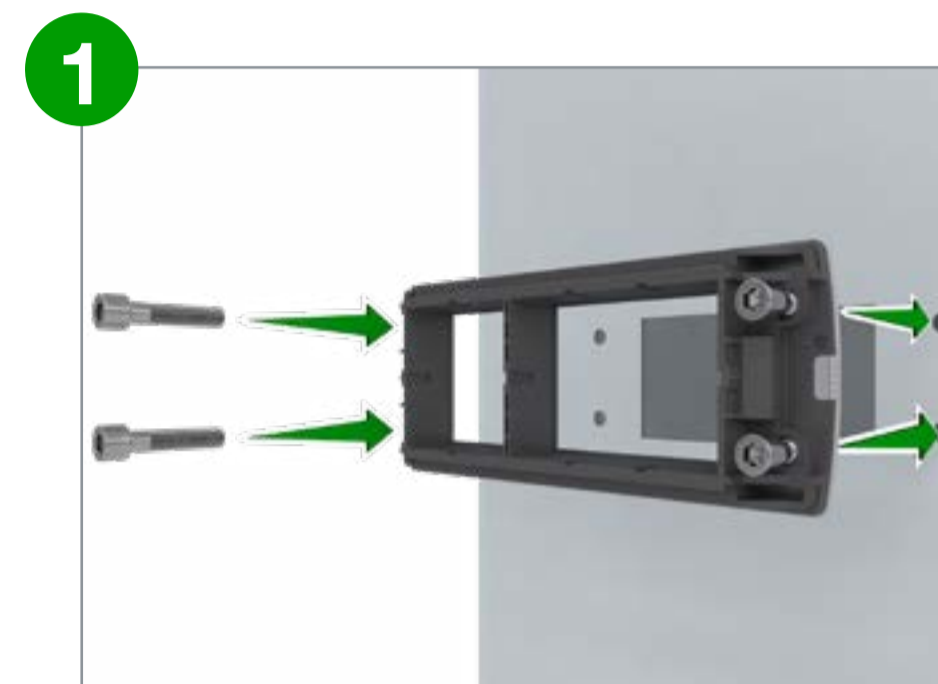

1 Insert frame and screws from outside.

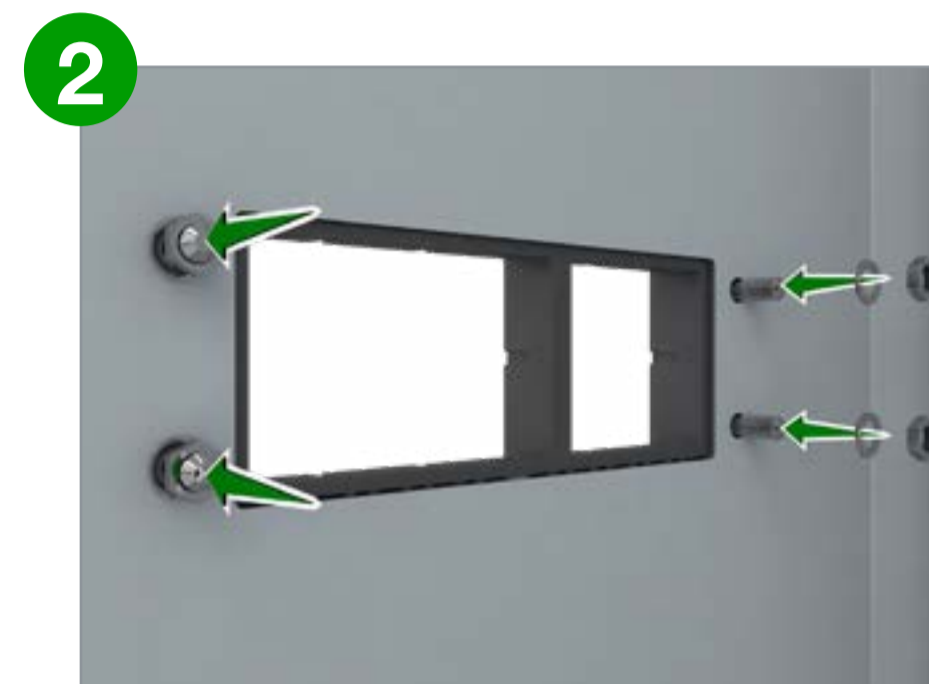

2 Insert washers and nuts. Tighten nuts from inside with 3 Nm torque.

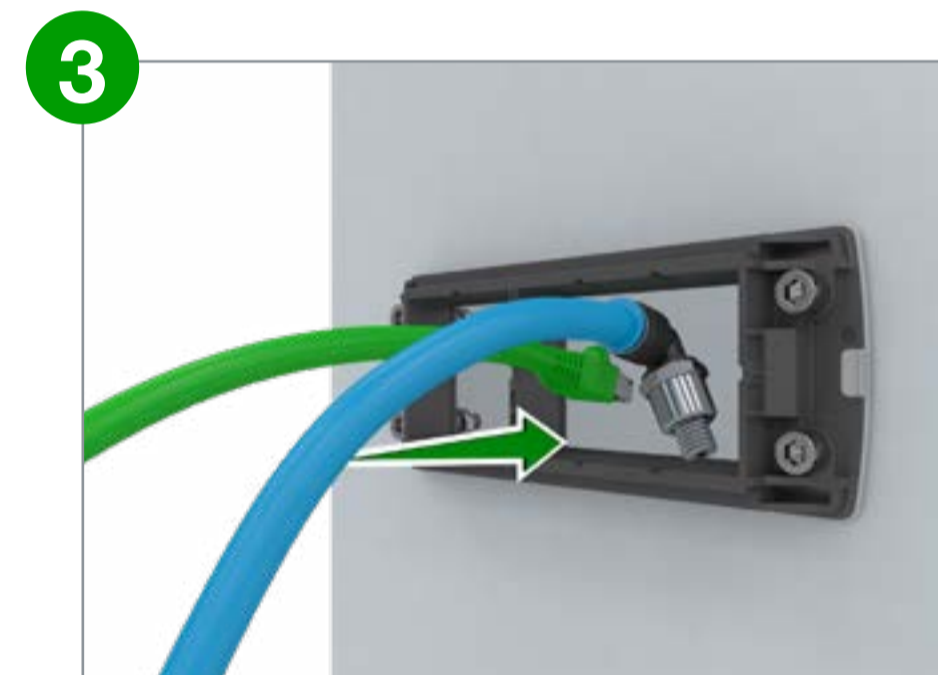

3 Guide cables through frame.

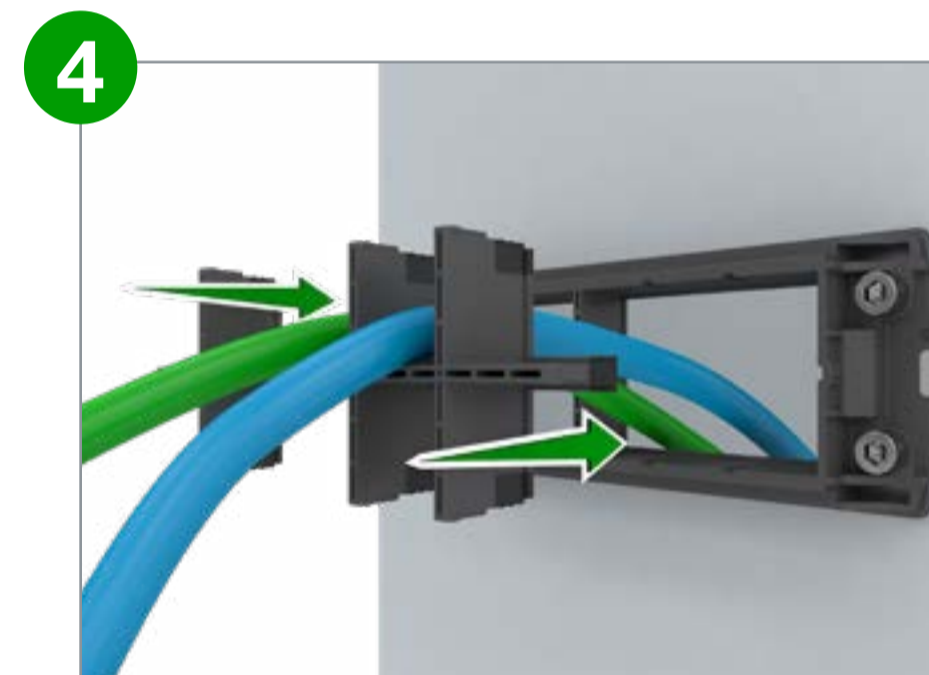

4 Click inlays into position.

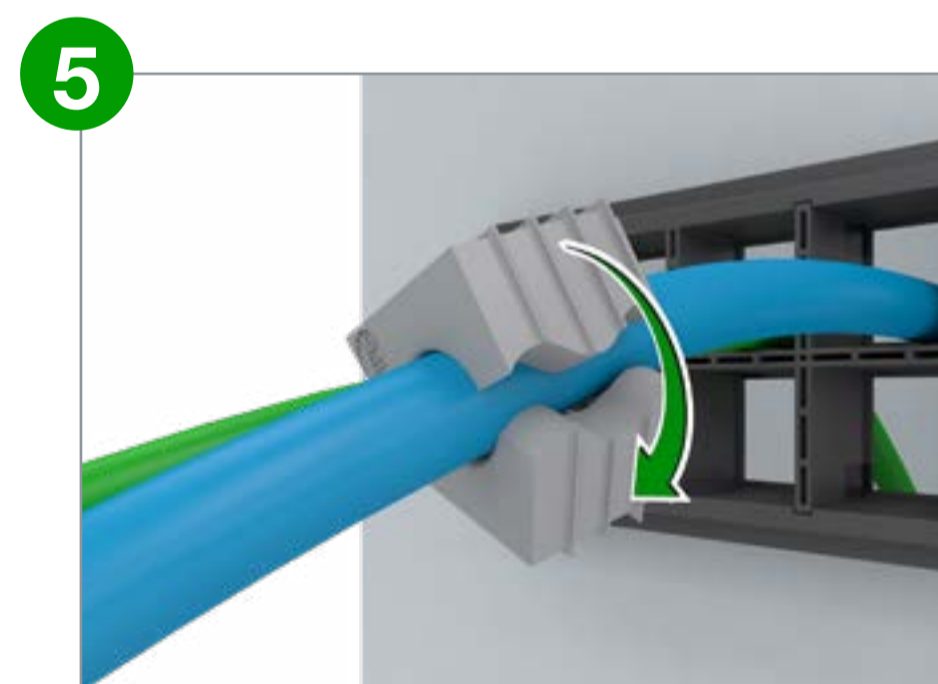

5 Attach seals to cables.

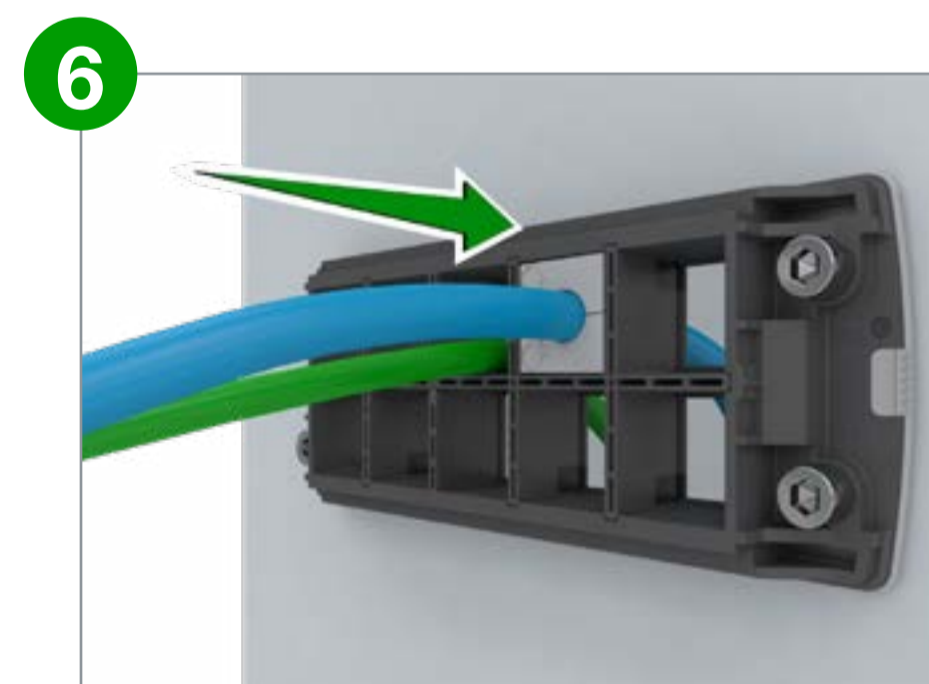

6 Push seals all the way in.

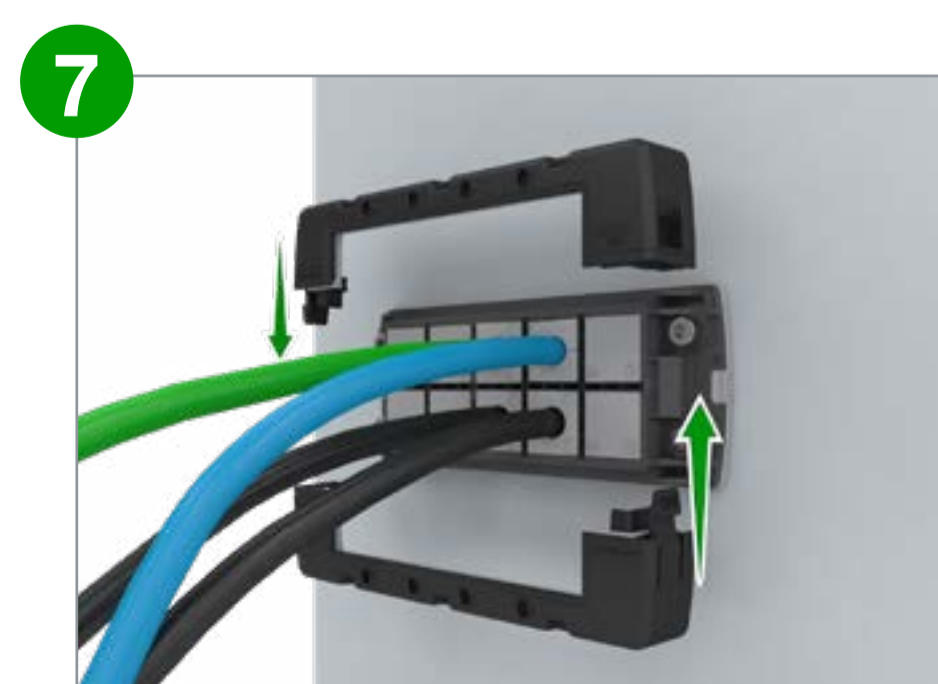

7 Assemble hood.

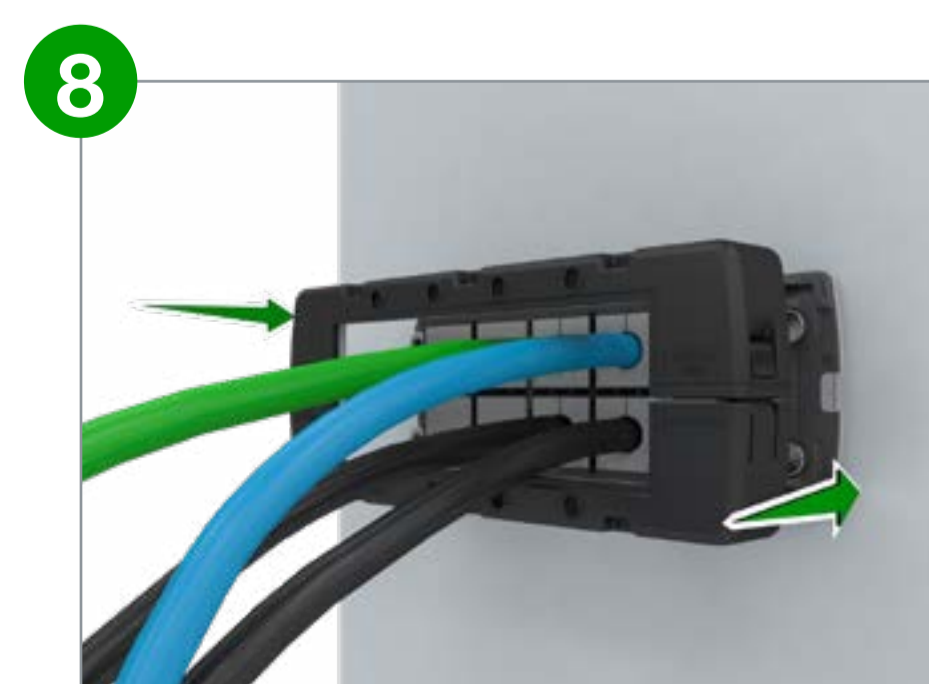

8 Snap hood onto frame.

OPTIONAL OUTER LOCKING BARS

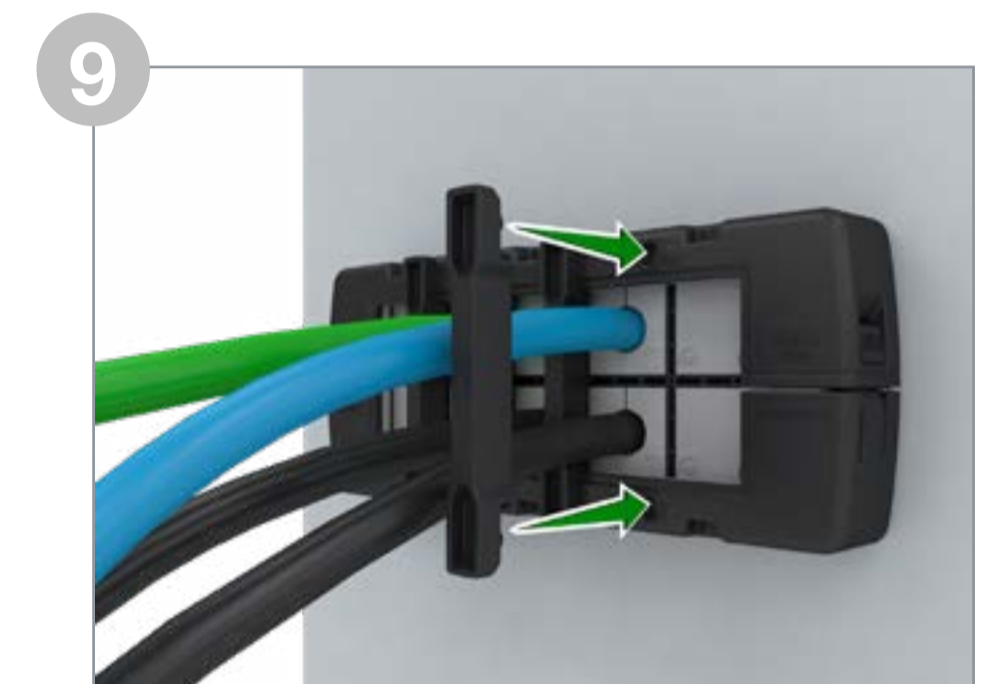

9 Snap the optional locking bars into position in the frame.

TO REMOVE THE HOOD

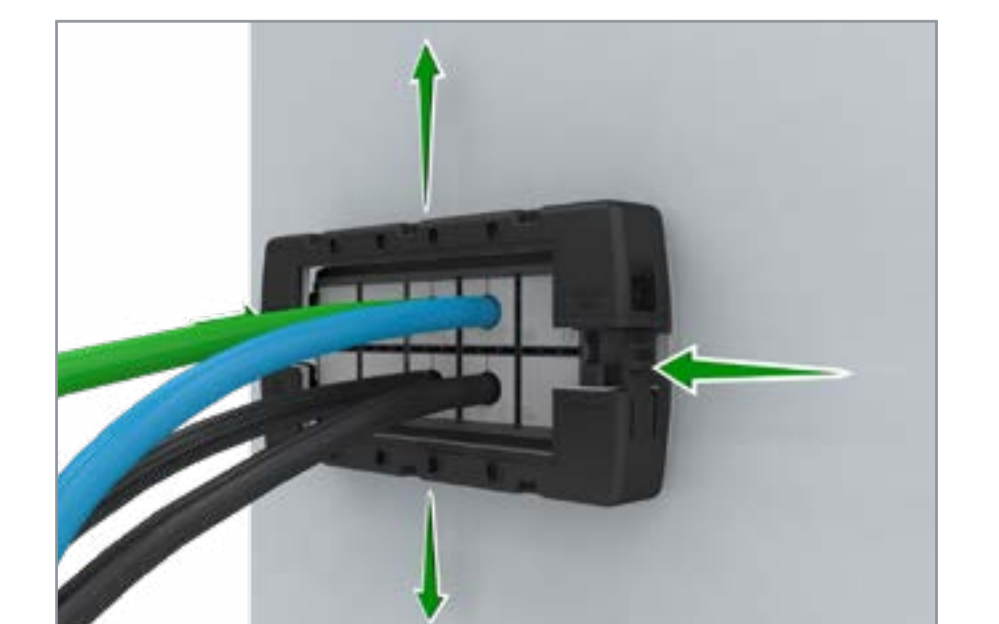

Remove optional locking bars. Press tabs on sides and pull apart.

CONTA-CABLE/ KDSI-SR KABELINFÜHRUNGEN



EN DE

PRODUKTDATEN

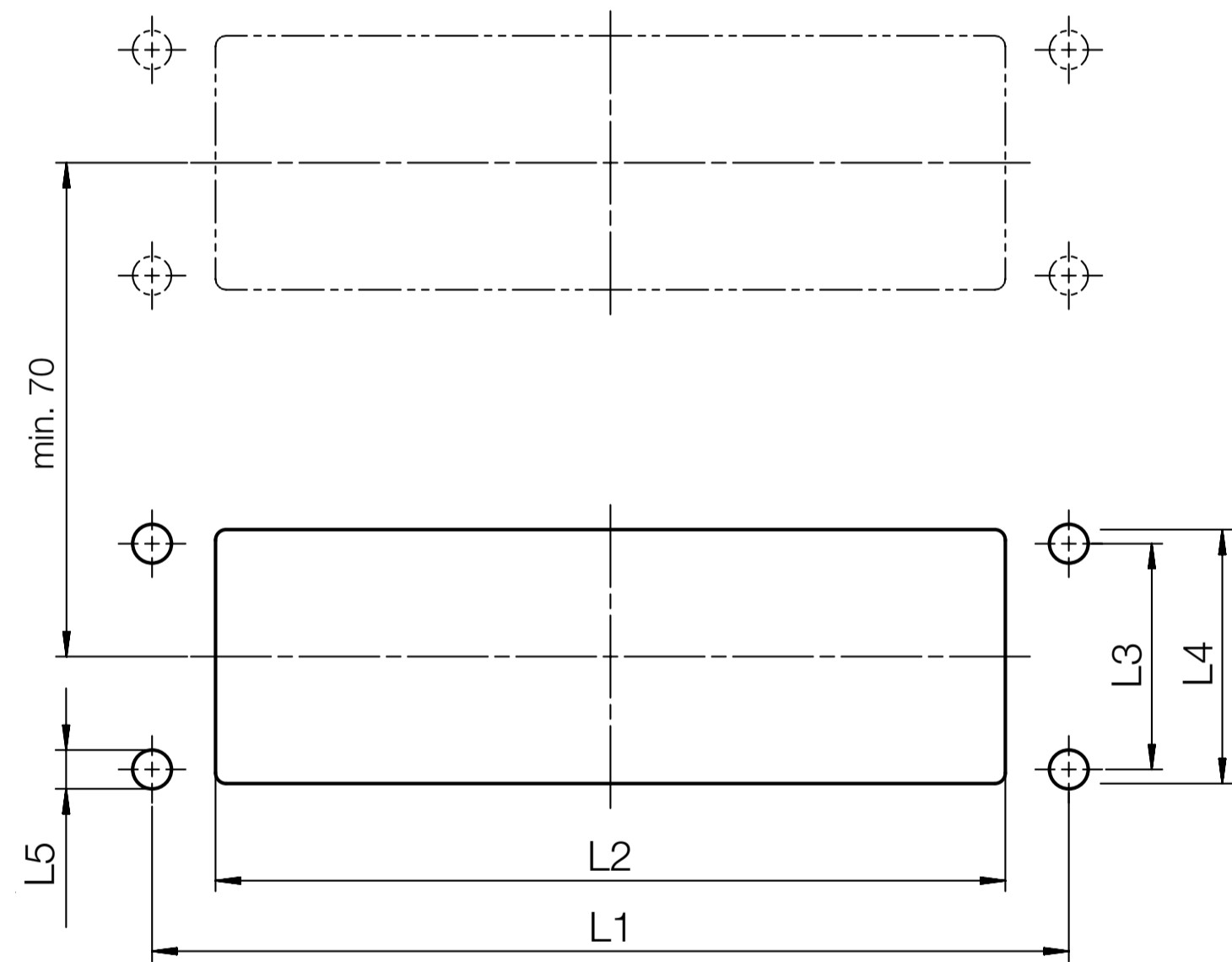
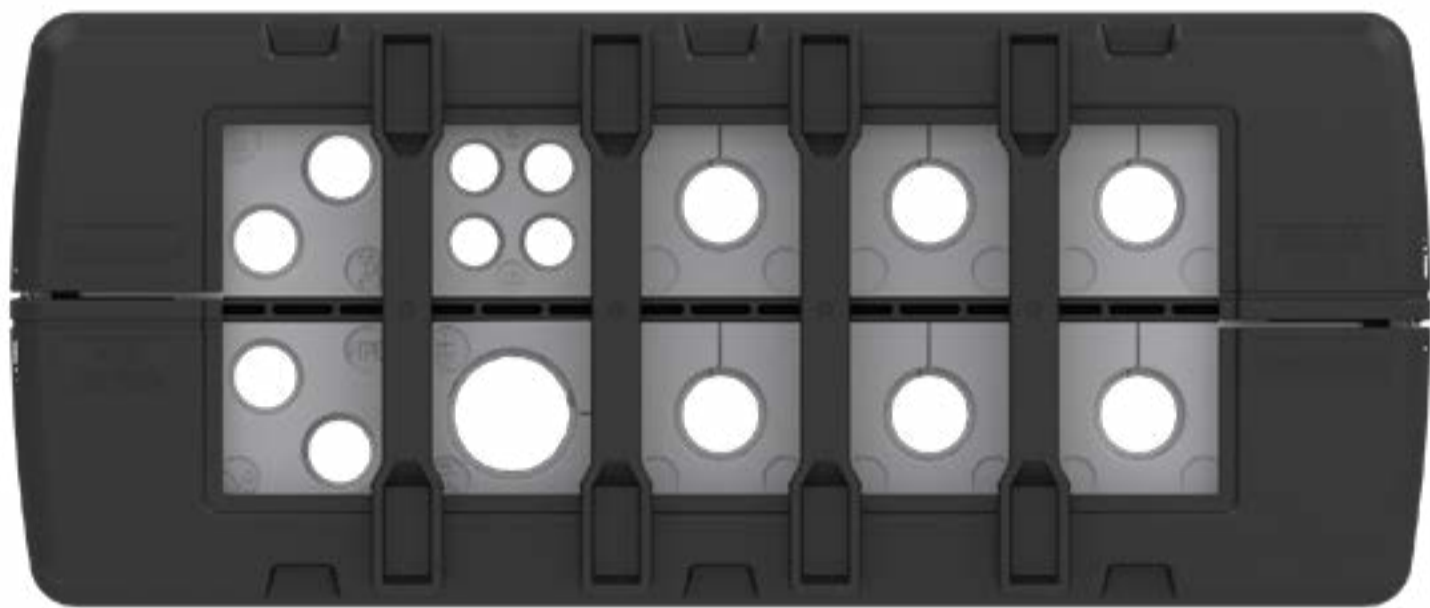

ABMESSUNGEN MONTAGEAUSSCHNITTE

Rahmen	Kat.-Nr.	L1(mm)	L2(mm)	L3(mm)	L4(mm)	L5(mm)
KDSI-SR 1-4	28880.4	58	46	32	36-46	5.5
KDSI-SR 6/10	28881.4	83	68.5	32	36-46	5.5
KDSI-SR 8/16	28882.4	103	91	32	36-46	5.5
KDSI-SR 10/24	28883.4	130	113.5	32	36-46	5.5

ANWENDUNGSMÖGLICHKEITEN

Rahmen	Inlay			
	1	2	4	6
KDSI-SR 1-4	28516.4	28517.4	28518.4	28519.4
KDSI-SR 6/10		x	x	x
KDSI-SR 8/16	x		x	
KDSI-SR 10/24		x	x	x

INSTALLATION

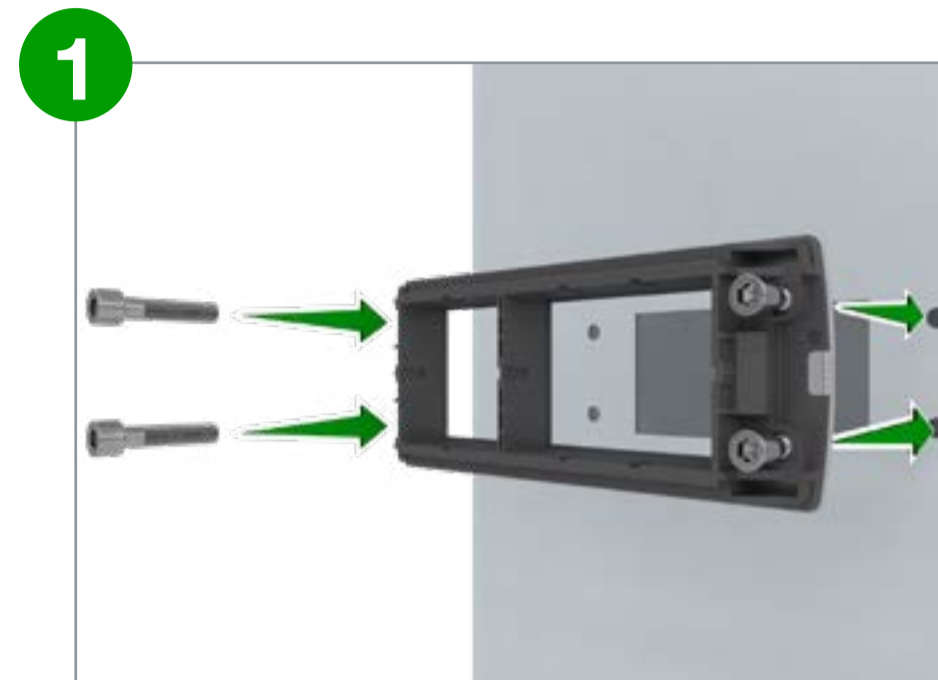

1 Rahmen und Schrauben von außen einsetzen.

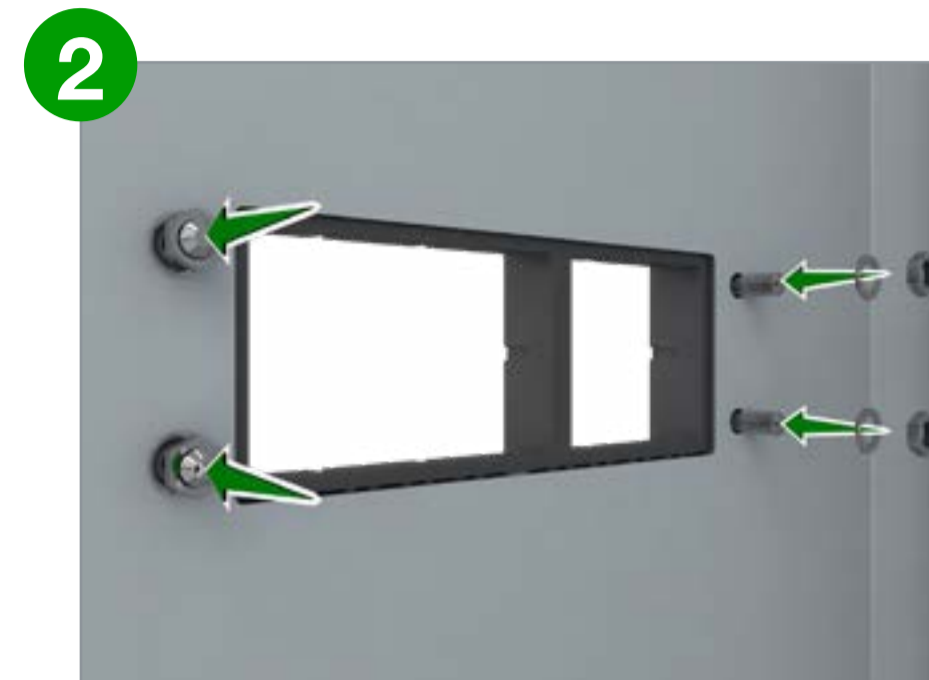

2 Unterlegscheiben und Muttern einsetzen. Muttern von innen mit einem Drehmoment von 3 Nm festziehen.

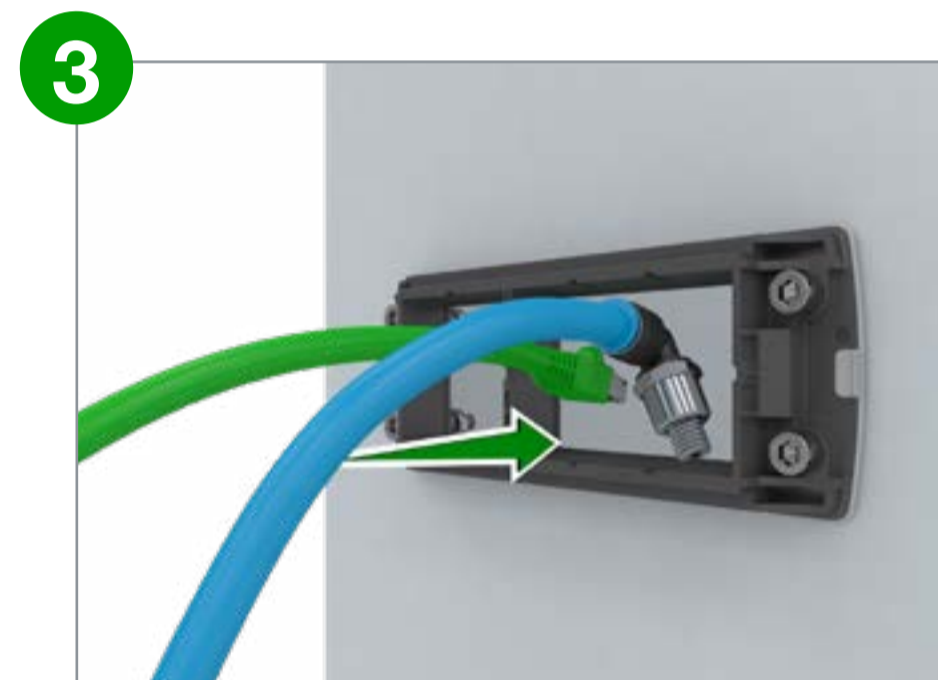

3 Die Kabel durch den Rahmen führen.

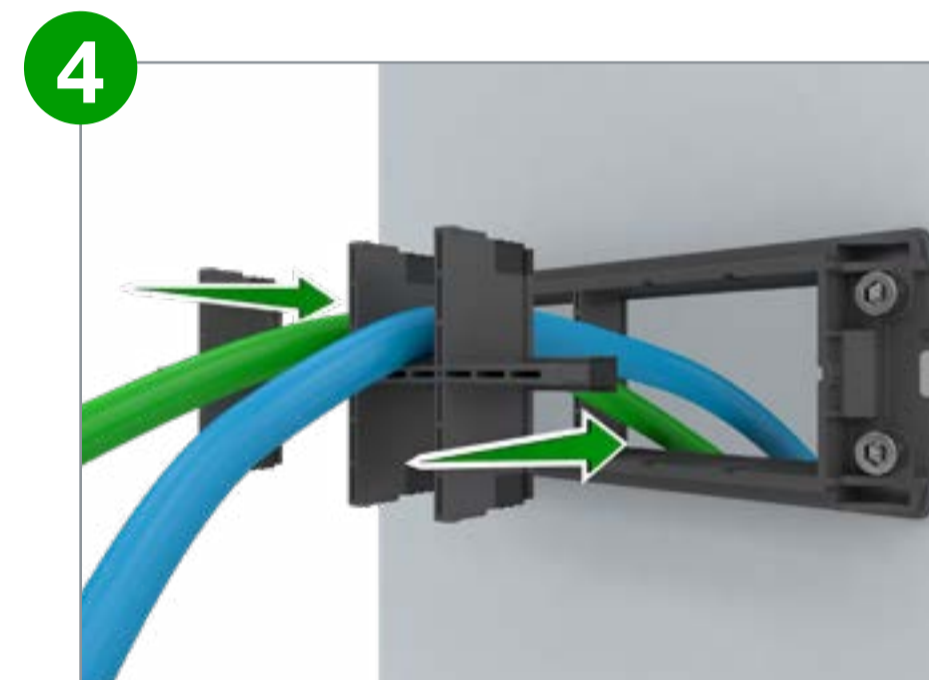

4 Die Inlays in ihre Position einrasten.

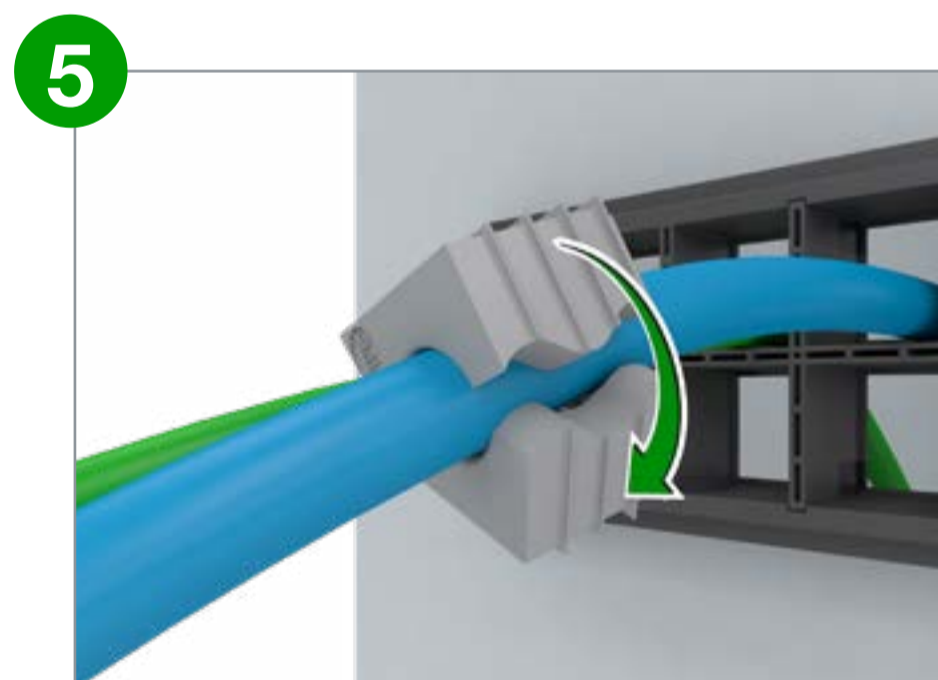

5 Die Dichtungen an den Kabeln anbringen.

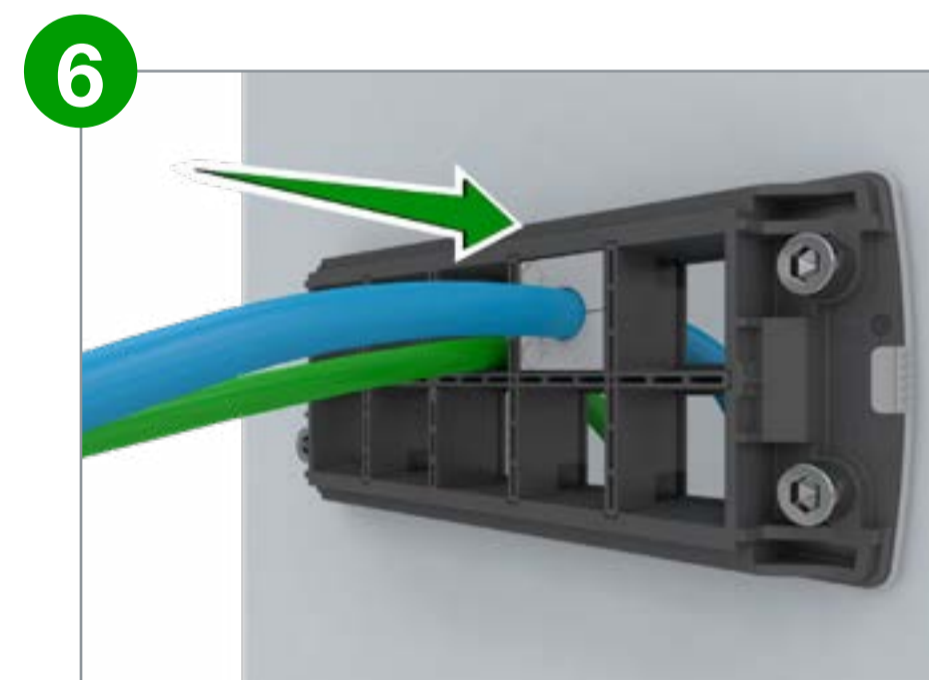

6 Die Dichtungen vollständig eindrücken.

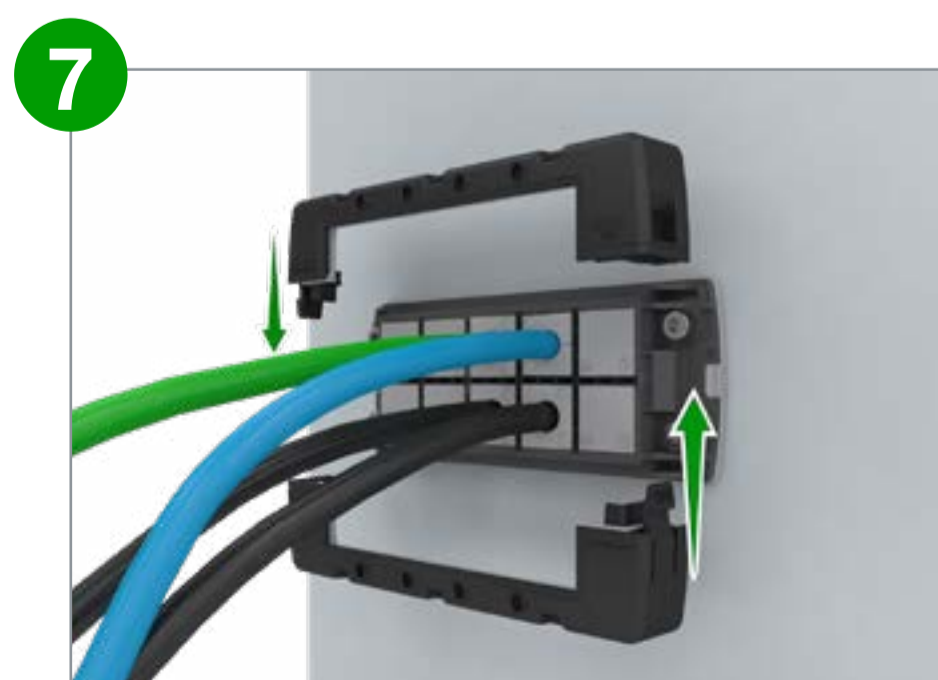

7 Abdeckhaube anbringen.

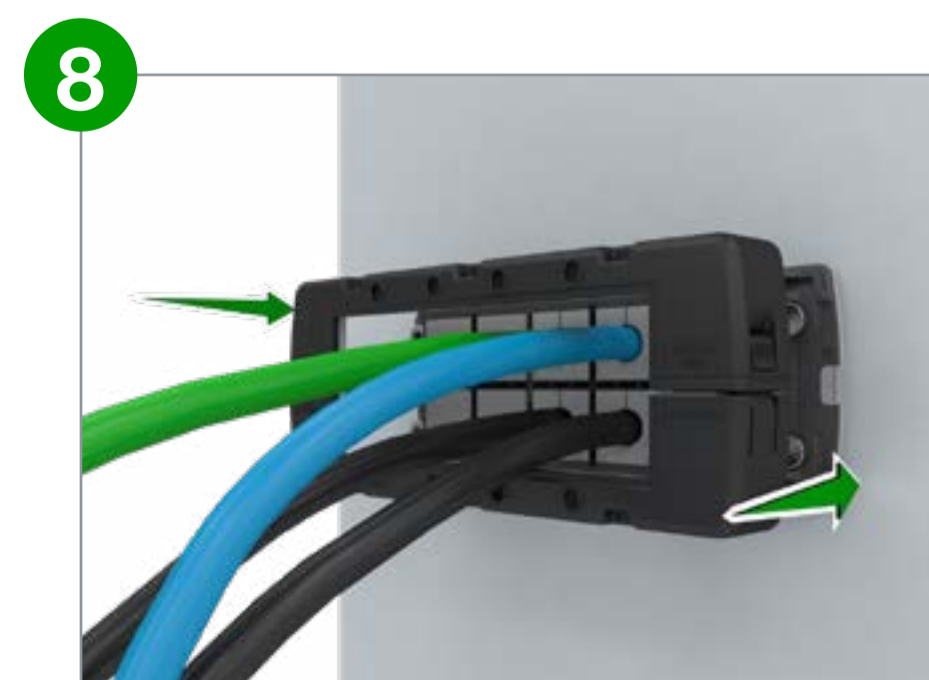

8 Die Abdeckhaube am Rahmen einrasten.

OPTIONALE ÄUSSERE VERRIEGELUNG

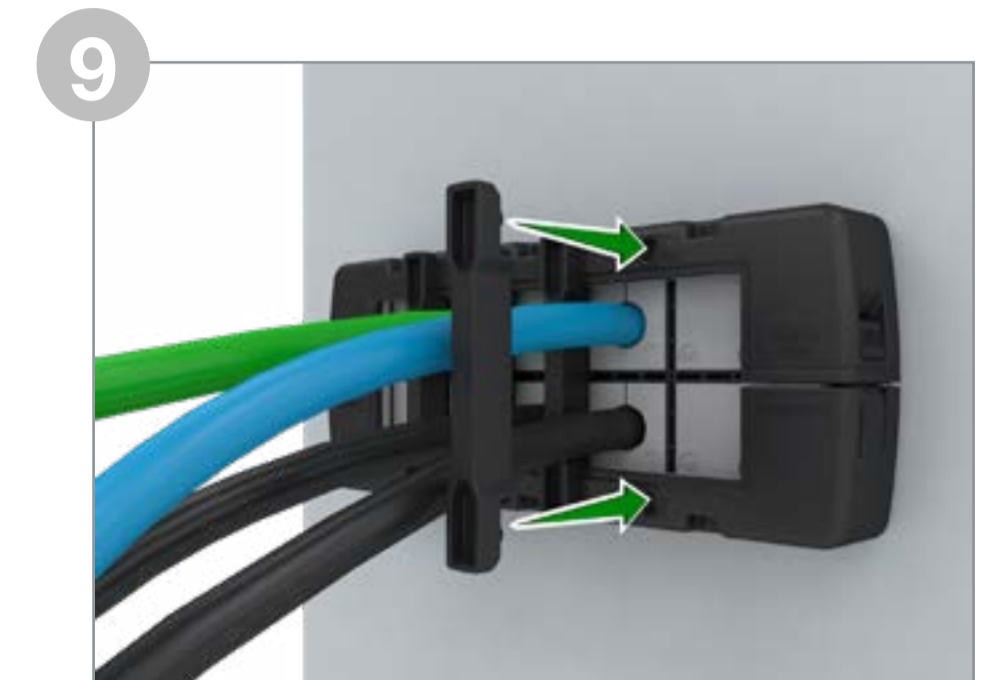

9 Die optionalen Verriegelungen in die Position im Rahmen einrasten.

ZUM ABNEHMEN DER ABDECKHAUBE

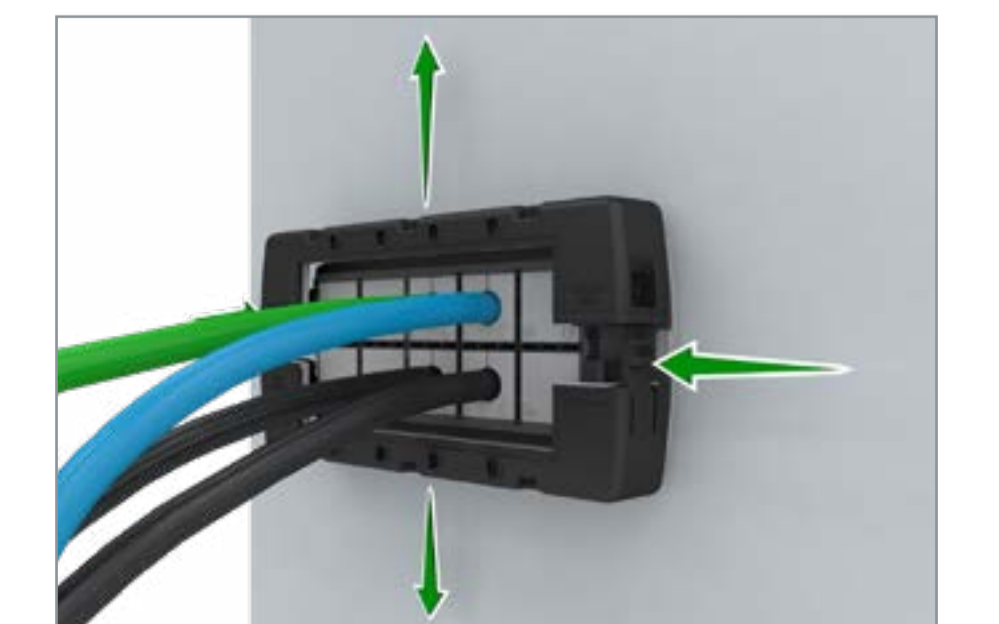

Optionale Verriegelungen entfernen. Die Laschen an den Seiten eindrücken und dann auseinanderziehen.